

# Earthquake Home Hazard Hunt

FEMA 528 9/2005

Recommendations for reducing earthquake hazards in your home are presented on the other side of this poster.

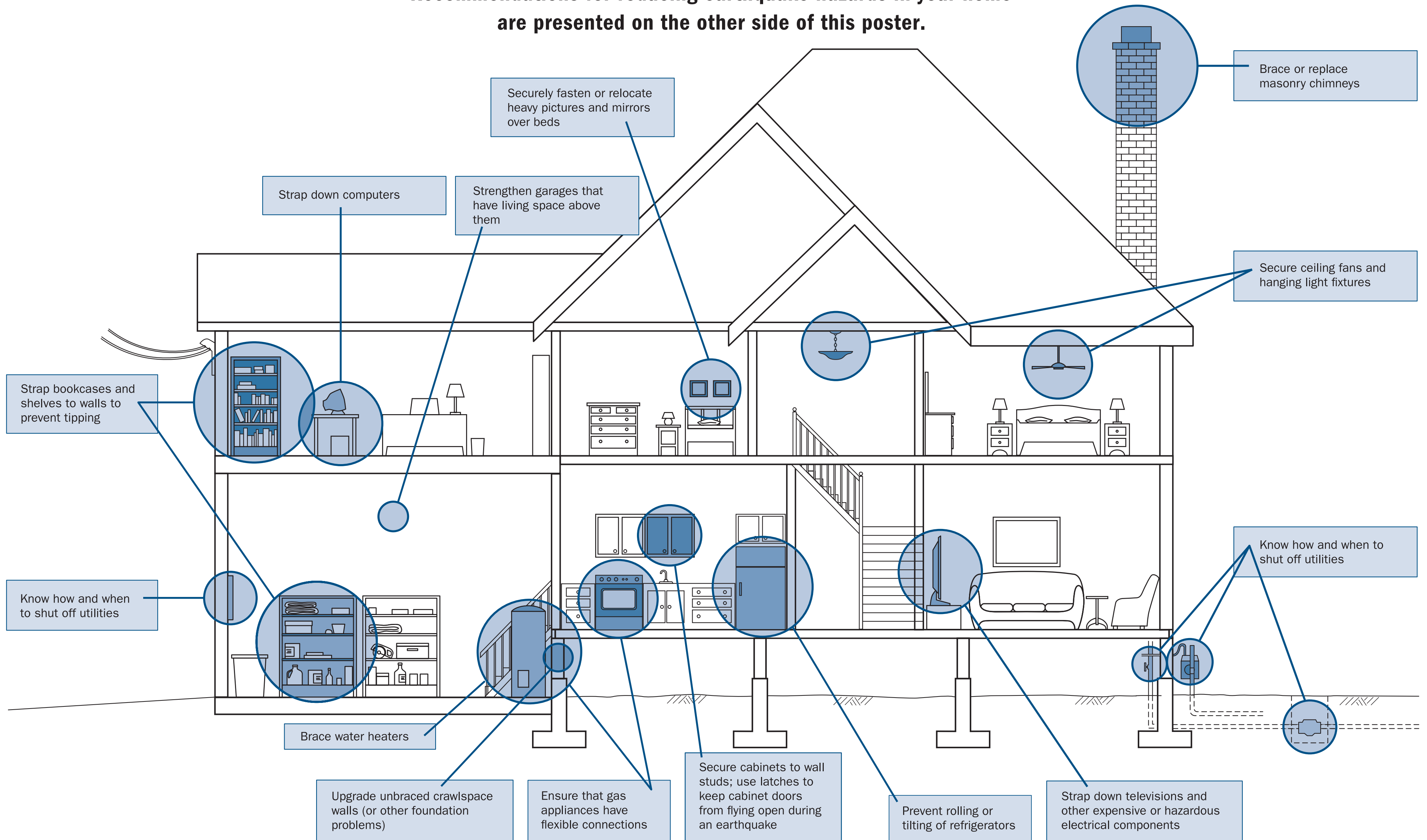

# Earthquake Home Hazard Hunt

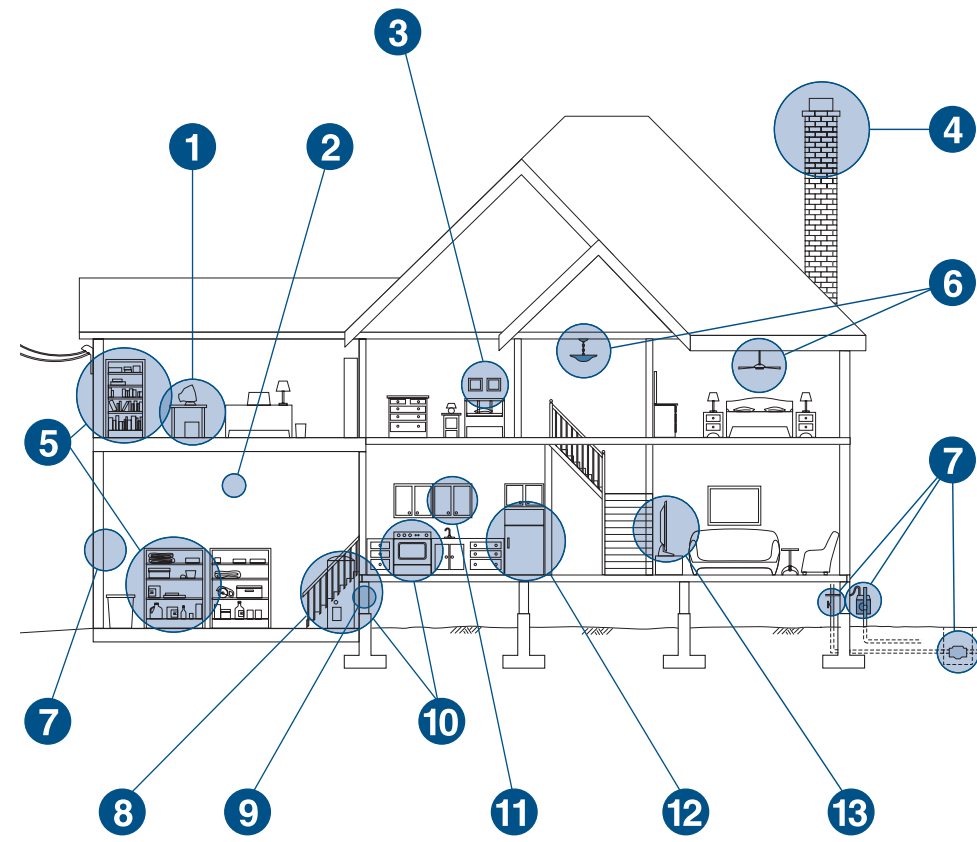

This poster has information for you and your family to help you find and fix areas of your home that might be damaged in an earthquake and that might injure family members during an earthquake. Information is also provided on planning for an earthquake and safety steps you can take during and after an earthquake.

Your earthquake home hazard hunt should begin with all family members participating. Foresight, imagination, and common sense are all that are needed as you go from room to room imagining what would happen if the earth and house started shaking. Anything that can move, break, or fall when your house starts to shake is a potential hazard.

## What would happen to heavy furniture, fixtures, and appliances?

- Look at tall bookcases and shelves. How much would fall off the shelves? Would the whole bookcase topple, or is it anchored to the wall? Anchor bookcases and other top-heavy furniture to wall studs using flexible fasteners (e.g., nylon straps) **5**
- Prevent refrigerators, washers, and other heavy appliances from moving by blocking the rollers **12**
- Add bracing to support air conditioners, particularly on rooftops.
- Do you have hanging light fixtures or plants? Could they swing and hit a window or swing off their hooks? As a minimum precaution, transfer hanging plants from heavy clay pots to lighter ones and used closed hooks on all hanging items **6**

## Check for possible flying glass.

- Replace glass bottles in the medicine cabinet and around the bathtub and shower with plastic containers.
- What kind of latches are on your kitchen cabinets? Consider replacing magnetic "touch" latches with ones that will hold the cabinet doors shut during an earthquake. In some cases, a lip or low barrier across shelves may prevent breakables from sliding out **11**
- Where do you sit or sleep? Anchor heavy mirrors and pictures over beds, chairs, and couches with wire through eye screws into studs. Locate beds away from windows **3**

## Think about fire safety.

- Remove all flammable liquids, such as painting and cleaning products, to the garage or outside storage area. Be sure these items are secured on their shelves or stored away from heat sources and appliances, particularly your water heater and furnace.
- Secure gas lines by installing flexible connectors to appliances **10**
- Is your water heater secured? Metal straps can be used to fasten your water heater to the wood studs of the nearest wall **8**

## What would happen to the house itself?

- Look at the outside of your home. What about your chimney? Masonry chimneys pose a real hazard in earthquakes, especially the freestanding section above the roof line, as bricks may fall into the house **4**
- Check your roof. Make sure all tiles are secured – loose tiles could fall.
- Check foundation for loose or cracked plaster.
- Secure the wood sill and wall framing to the foundation using anchor bolts.
- Sheath crawlspace walls with plywood to prevent collapse **9**
- Strengthen connections between posts and beams with bracing.

With your powers of perception more finely tuned, you may wish to extend these suggestions to your workplace. Check to determine whether your company has an earthquake safety plan.

Children can share their new awareness in the classroom. Determine whether their school has a practical earthquake plan, whether earthquake drills are held, and what the policy is if an earthquake occurs while school is in session.

## Correcting Problems

### Utilities **7**

Teach responsible members of your family how to turn off electricity, gas, and water at main switch and valves. **Caution:** Do not shut off gas unless an emergency exists. If gas is ever turned off, a professional must restore service. Contact your local utilities for more information.

Label the water shut-off valve, found where water enters the house. Also the main water shut-off valve, found with the meter in a concrete box in the sidewalk or yard.

### Weak Crawlspace Walls **9**

Wooden floors and stud walls are sometimes built on top of an exterior foundation to support a house and create a crawlspace. These walls carry the weight of the house. During an earthquake, these walls can collapse if they are not braced to resist horizontal movement. If the walls fail, the house may shift or fall.

You can look under your house in the crawlspace to see whether there are any wood stud walls supporting the first floor. Check to see whether the stud walls are braced with plywood panels or diagonal wood sheathing. If your house has neither of these, the wood stud crawlspace walls are probably insufficiently braced or are unbraced. Please note that horizontal or vertical wood siding is not strong enough to brace wood stud crawlspace walls.

Plywood or other wood products allowed by code should be nailed to the studs (see **Figure A**) to strengthen your foundation. The type of wood product used, the plywood thickness, and nail size and spacing are all important when making this upgrade.

Many other types of foundation walls are used in the United States that may need upgrading to resist earthquake damage. Check with your local Building Department or a licensed architect or engineer for recommendations on how to determine whether your foundation and walls are likely to be damaged in an earthquake and what upgrades may be needed. Check with local officials for permit requirements before starting work.

Remember, it is very expensive to lift a house, repair the foundation and walls, and put it back on its foundation, while upgrading before an earthquake will be much less costly.

### Garages With Living Spaces Above **2**

The large opening of a garage door and the weight of a second-story room built over the garage can result in the garage walls being too weak to withstand earthquake shaking, resulting in severe damage. If the narrow sections of the wall on each side of the garage door opening are not reinforced or braced, the potential for earthquake damage is greater.

Look at the area around the garage door opening – are there braces or plywood panels? If not, strengthening may be needed. Consult a licensed architect or engineer to determine the strengthening required to upgrade your garage walls. Your home may need to have plywood paneling or a steel frame designed and installed around the door opening (see **Figure B**). Remember to obtain a permit from your local Building Department before starting work.

### Chimney Bracing **4**

To prevent the chimney from breaking away from the house, you should have it secured to the framing of the roof with sheet metal straps and angle bracing (see **Figure C**). If your roof doesn't have solid sheathing, consider adding plywood panels above the ceiling joists. Have the chimney inspected by a professional to determine whether the chimney should be upgraded or replaced.

**Figure C. Bracing masonry chimneys.**

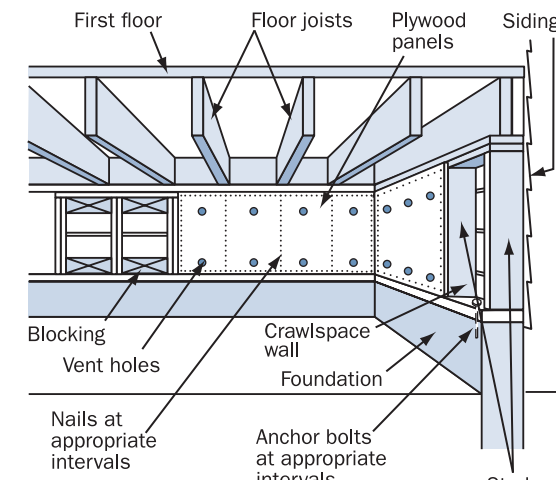

**Figure A. Strengthening weak crawlspace walls.**

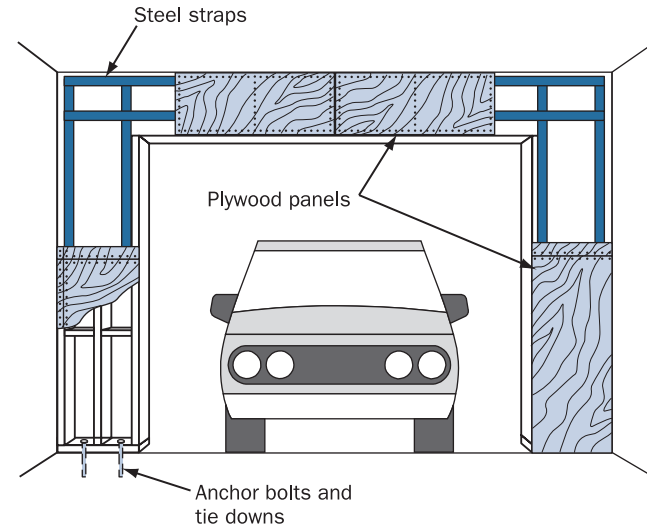

**Figure B. Strengthening garage walls below living space.**

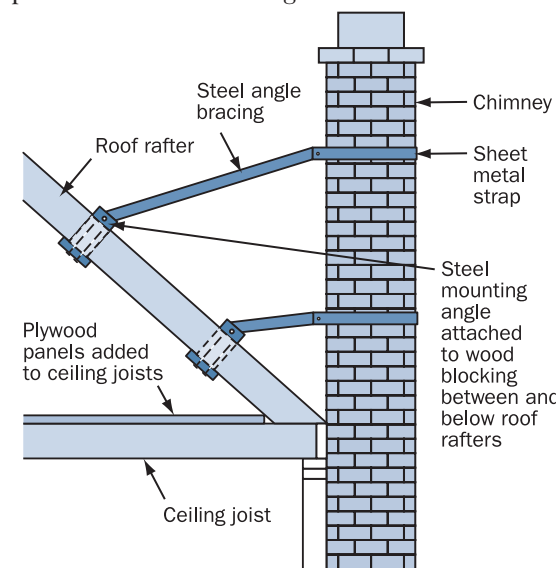

### Hanging Objects **3**

Prevent wall hangings from bouncing off walls:

- Secure mirrors, pictures, plants, and other objects on closed hooks.
- Secure the bottom corners with earthquake putty or adhesive pads.
- Place only soft art such as tapestries over beds and sofas.

### Home Electronics **1 13**

Electronics are heavy objects and costly to replace. Secure TVs, stereos, computers, and microwaves with earthquake-resistant flexible nylon straps and buckles for easy removal and relocation (see **Figure D**).

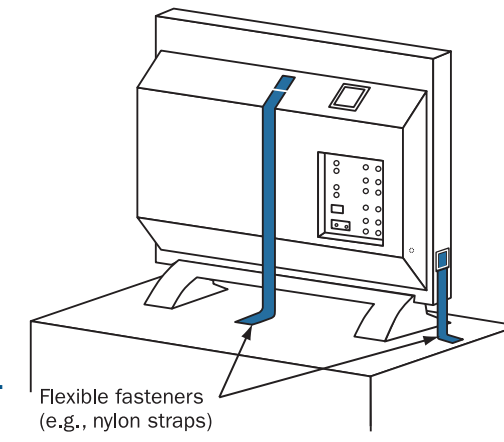

**Figure D. Securing home electronics.**

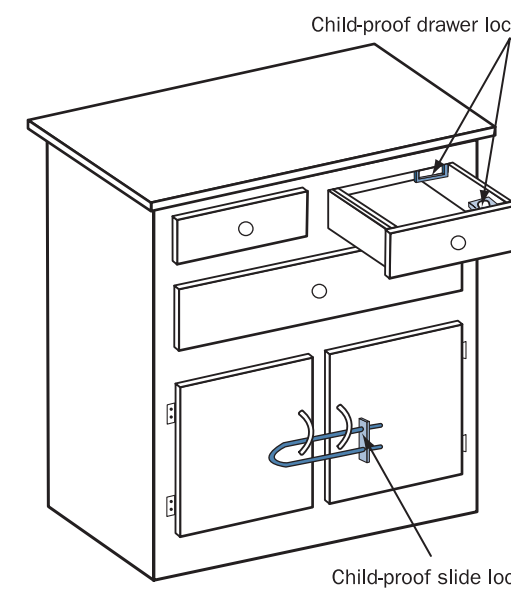

**Figure E. Securing cabinet doors and draws.**

### In the Kitchen **10 11 12**

Cabinet doors, refrigerators, and gas appliances should be secured so that they will not move or fall over during an earthquake.

- First, secure all cabinets above waist level securely to the wall studs.
- Use latches designed for earthquake, child-proofing, or boat safety to keep cabinet doors from flying open and contents falling (see **Figure E**).
- Have a plumber install flexible connectors on gas appliances.

### Furniture **5**

Follow these important guidelines:

- Secure all tall, top-heavy furniture such as bookcases, wall units, and entertainment centers (see **Figure F**). Attach them securely to the wall studs with straps.
- Secure the top, on both the right and left sides of the unit, into wall studs, not just into the drywall.
- Use flexible mount fasteners such as nylon straps to allow furniture independent movement from the wall, reducing the strain on studs.
- Secure loose shelving by applying earthquake putty on each corner bracket.
- Store heavy items and breakables on lower shelves.

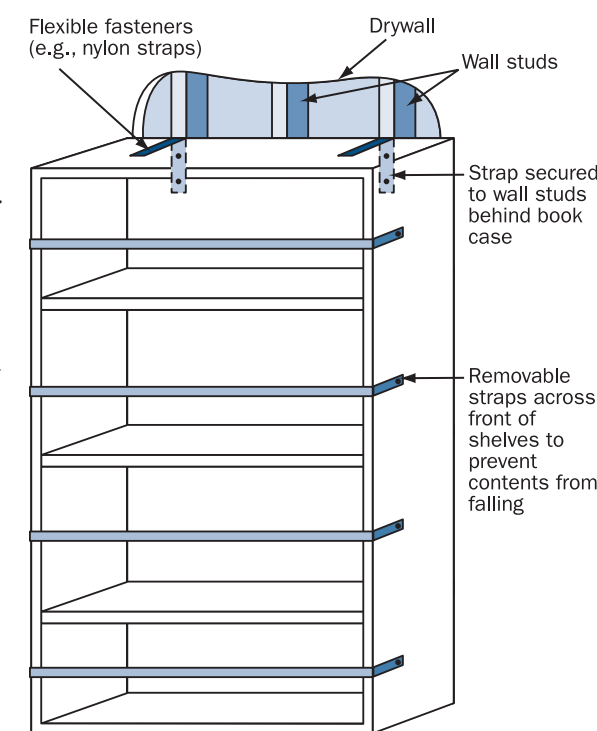

**Figure F. Securing top-heavy furniture.**

### Water Heaters **8 10**

Water heaters should be braced (see **Figure G**). There are many solutions – all relatively inexpensive.

Purchase and install a strap kit or bracing kit from your local hardware store.

Other options include:

- Have a licensed plumber strap your water heater according to code.
- Use heavy metal strapping and screws to secure the water heater to the wall studs.

The gas and water lines should have flexible connector pipes. These are safer than rigid pipes during an earthquake. Be sure to check the straps once a year. They may come loose as a result of vibrations or other causes.

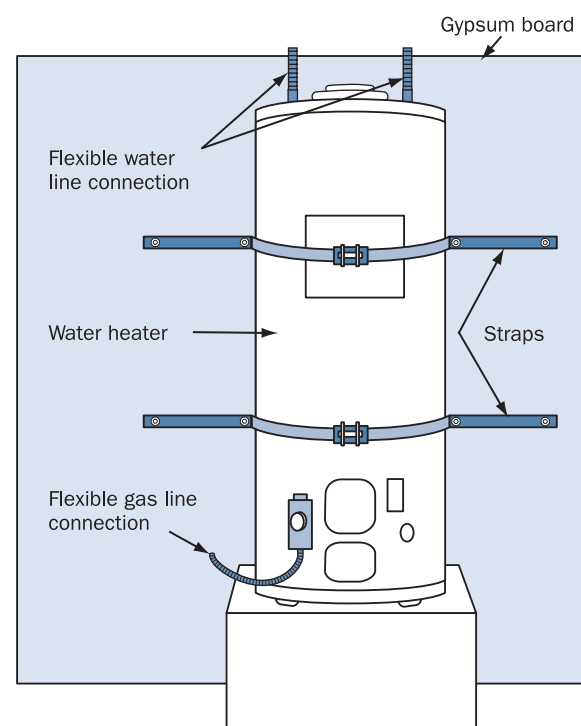

**Figure G. Securing water heaters.**

## Take Action To Protect Yourself and Your Family From Earthquakes

### Create and Practice Your Disaster Preparedness Plan

An emergency preparedness plan includes life-critical actions, life saving training, and the advance plans to enable you to respond to earthquakes and potential physical injuries and hazards no matter where you are.

#### Life-Critical Actions – Learn how to:

- Drop, cover, and hold.
- Signal for help, if you are trapped somewhere. Teach children and adults to use an emergency whistle and/or to knock three times repeatedly if trapped. Rescuers searching collapsed buildings will be listening for sounds.

#### Life Saving Training – Consider training in:

- First Aid
- CPR
- How to use a fire extinguisher
- How to shut off gas, water, and electricity

#### Your Disaster Preparedness Plan Should Include:

- Disaster Supplies Kits for home, workplace, and car
- Practicing Drop, Cover, and Hold
- Financial Plan
- Family Communications Plan that each family member understands
- Needs for all family members, including children, seniors, and pets

#### Financial Plan

You should store your family's documents, such as insurance policies, deeds, property records, birth certificates, and other important papers, in a safe place away from your home (e.g., safety deposit box). Make copies of important documents for your disaster supplies kit.

Consider saving money in an emergency savings account that could be used in any crisis. Back up critical files on your computer and keep a copy in a safe place away from your home.

### Create Your Disaster Supplies Kit

Because you don't know where you and your family will be when an earthquake occurs, prepare a Disaster Supplies Kit for your home, workplace, and car. For detailed information about the items that should be included in your disaster supplies kit, refer to FEMA 526, *Earthquake Safety Checklist*.

### Family Earthquake Drill

It's important to know where you should go for protection when your house starts to shake. By planning and practicing what to do before an earthquake occurs, you can condition yourself and your family to react correctly and spontaneously when the first jolt or shaking is felt. An earthquake drill can teach your family what to do in an earthquake.

- Each family member should know safe spots in each room.
- Safe spots: The best places to be are under heavy pieces of furniture, such as a desk or sturdy table; under supported archways; and against inside walls.
- Danger spots: Stay away from windows, hanging objects, mirrors, fireplaces, and tall, unsecured pieces of furniture.
- Reinforce this knowledge by physically placing yourself in the safe locations. This is especially important for children.
- In the days or weeks after this exercise, hold surprise drills.
- Be prepared to deal with what you may experience after an earthquake – both physically and emotionally.
- Following the drop, cover, and hold procedure is the best way to be safe during an earthquake.
- Take cover under a sturdy desk, table, or bench and hold on to the desk or table leg so that desk or table stays on top of you. Hold on until the earthquake shaking stops.
- Family members should practice drop, cover, and hold in the safe spots that you and your family have identified.

## Further Information

For more information about earthquake preparedness and safety, refer to the following publications, which are available from the FEMA Distribution Facility at 1-800-480-2520. As noted, some are available for download from the FEMA website.

*After Disaster Strikes: How to recover financially from a natural disaster*, FEMA 292. Available in both English and Spanish.

*Are You Ready? An In-depth Guide to Citizen Preparedness*, IS-22, August 2004. Full publication and individual sections available online in both English and Spanish at [http://fema.gov/preparedness/prepare\\_guides\\_links.shtm](http://fema.gov/preparedness/prepare_guides_links.shtm).

*Before Disaster Strikes: How to make sure you're financially prepared to deal with a natural disaster*, FEMA 291, May 1997. Available in both English and Spanish.

*Earthquake Safety Checklist*, FEMA 526, August 2005.

*Earthquake Safety Guide for Homeowners*, FEMA 530, September 2005.

*Food and Water in an Emergency*, FEMA 477, August 2004. Available online in both English and Spanish at [http://fema.gov/preparedness/prepare\\_guides\\_links.shtm](http://fema.gov/preparedness/prepare_guides_links.shtm).

*Preparing for Disaster for People with Disabilities and Special Needs*, FEMA 476, August 2004. Available online in both English and Spanish at [http://fema.gov/preparedness/prepare\\_guides\\_links.shtm](http://fema.gov/preparedness/prepare_guides_links.shtm).

Visit the FEMA website at <http://www.fema.gov/hazards/earthquakes/> for information about the National Earthquake Hazards Reduction Program (NEHRP) and more ways to address earthquake risks.